

Triconfort 1950
2 Seater sofa
by Kettal Studio

kettal

2 Seater sofa

Designer
Kettal Studio

Collection
Triconfort 1950

Reference
KS7200600

1/3

The 1950 collection combines the art of forging with 21st century technology. Once fashioned from heavy iron, the pieces are now ingeniously crafted from aluminum, a much lighter and weather-resistant material. Like any good design, their aesthetics respond to their structure. An evocation of the special triangulated constructions from which engineers and architects developed most of their civil works during the second half of the 19th century.

cm/inch

79/31,1

45/17,7

35/13,7

cm/inch

80/31,4

162/63,7

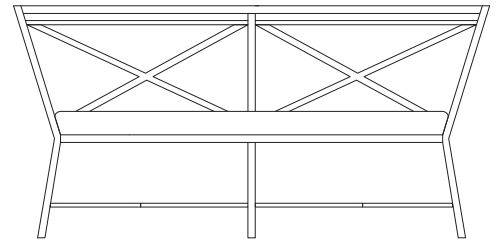
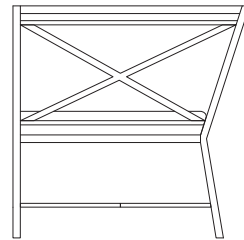

kettal

2 Seater sofa

Designer
Kettal Studio

Collection
Triconfort 1950

Reference
KS7200600

2/3

Materials

Fabric
Heavy Load 100.000 Cycles,
Heavy Load Resistant 1000
Decitex, Kettalize-It, Resist U.v.
En-581-4, Easy Clean, Abrasion,
Resistance 30.000 Cycles,
Quickdry

Aluminium
Antioxy, Heavy Load, Resistant
En-1421, Kettalize-It, Anti-
Scratch, Easy Clean, Flame
Retardant M1, Eco Friendly
Ecoembes Recycling Process

Maintenance

Clean with mild soap using
sponge or cloth. Be gentle
while cleaning, do not scrub
aggressively the fabric. Once
cleaned please make sure you
remove soap excess.

In case of aggressive stains
clean with diluted household
bleach.

Clean stains promptly. The
longer it remains, more difficult
will be to remove.

Once cleaned the fabric steam
iron the fabric. Just use steam,
be carefull NOT placing the
iron directly in the fabric it will
get damage.

Frame Colour Options



Chalk
721



Bone
678



Tuff
103



Mist
773



Flint
734



London Clay
729



Mahogany
100



Carbon
737



Lilac
104



Feldspar
082



Sepia
088



Terra Rossa
087

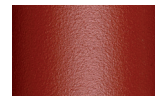

Magma
086



Terracota
085



Sahara
139

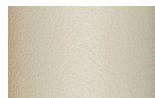

Camomile
106



Aquamarine
107



Cobalt
089

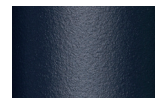

Indigo
094



Jade
091



Onyx
101



Juniper
092



Amazon
102



Bronze
093



Corten
727



Claystone
741



Sand Storm
132



Pumice
131



Galena
105



Manganese
726

2 Seater sofa

Designer
Kettal Studio

Collection
Triconfort 1950

Reference
KS7200600

3/3

Fabric Options

Terrain Fabrics Laminate

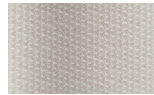

White Cliffs
290



Dry Sand
285

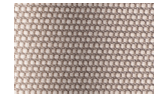

Porous Grey
291

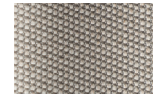

Limestone
292

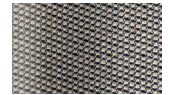

Fog
289



Deer
286



Wet Sand
287



Cobblestone
302



Cyprus Umber
301



Loam
297



Charcoal
293



Arctic
295

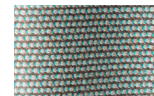

Fjord
248



Cerulean
314



Caribbean
298



Atlantic
311

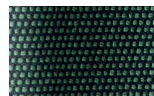

Rainforest
312

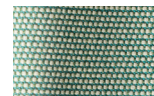

Lagoon
249



Cedar
288

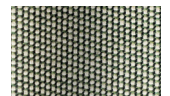

Moss
296



Olive
313

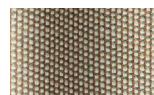

Autumn
315

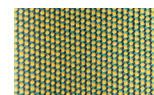

Summer Sky
317



Golden Sand
303



Flamma
304



Sunrise
299



Saffron
305



Burnt Sienna
306

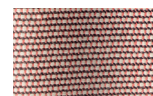

Ash Rose
294

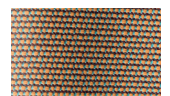

Cooper
316

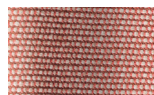

Dusk Pink
307



Flamingo
310



Coral
309



Sandstone
308

Triconfort 1950
3 Seater sofa
by Kettal Studio

kettal

3 Seater sofa

Designer
Kettal Studio

Collection
Triconfort 1950

Reference
KS7200800

1/3

The 1950 collection combines the art of forging with 21st century technology. Once fashioned from heavy iron, the pieces are now ingeniously crafted from aluminum, a much lighter and weather-resistant material. Like any good design, their aesthetics respond to their structure. An evocation of the special triangulated constructions from which engineers and architects developed most of their civil works during the second half of the 19th century.

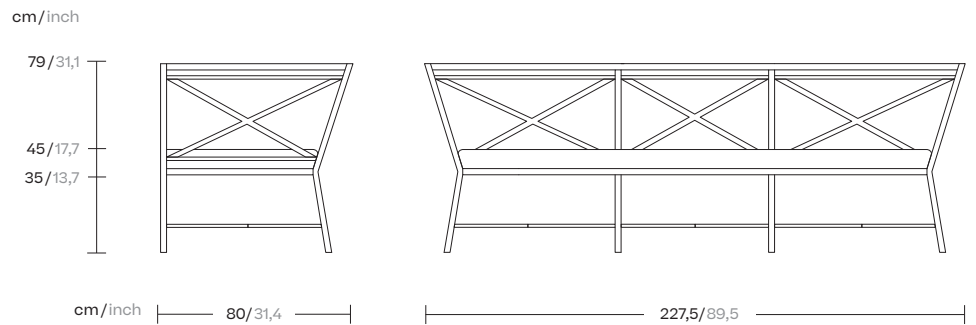

kettal

3 Seater sofa

Designer
Kettal Studio

Collection
Triconfort 1950

Reference
KS7200800

2/3

Materials

Fabric
Heavy Load 100.000 Cycles,
Heavy Load Resistant 1000
Decitex, Kettalize-It, Resist U.v.
En-581-4, Easy Clean, Abrasion,
Resistance 30.000 Cycles,
Quickdry

Aluminium
Antioxy, Heavy Load, Resistant
En-1421, Kettalize-It, Anti-
Scratch, Easy Clean, Flame
Retardant M1, Eco Friendly
Ecoembes Recycling Process

Maintenance

Clean with mild soap using
sponge or cloth. Be gentle
while cleaning, do not scrub
aggressively the fabric. Once
cleaned please make sure you
remove soap excess.

In case of aggressive stains
clean with diluted household
bleach.

Clean stains promptly. The
longer it remains, more difficult
will be to remove.

Once cleaned the fabric steam
iron the fabric. Just use steam,
be carefull NOT placing the
iron directly in the fabric it will
get damage.

Frame Colour Options



Chalk
721



Bone
678



Tuff
103



Mist
773



Flint
734



London Clay
729



Mahogany
100



Carbon
737



Lilac
104



Feldspar
082



Sepia
088

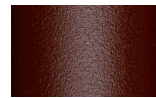

Terra Rossa
087

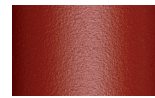

Magma
086



Terracota
085



Sahara
139

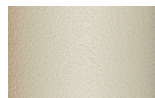

Camomile
106



Aquamarine
107



Cobalt
089

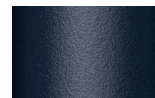

Indigo
094



Jade
091



Onyx
101



Juniper
092



Amazon
102



Bronze
093



Corten
727

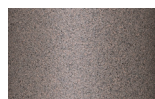

Claystone
741



Sand Storm
132



Pumice
131



Galena
105



Manganese
726

3 Seater sofa

Designer
Kettal Studio

Collection
Triconfort 1950

Reference
KS7200800

3/3

Fabric Options

Terrain Fabrics Laminate

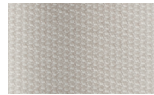

White Cliffs
290



Dry Sand
285

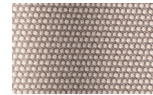

Porous Grey
291

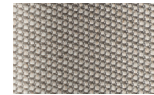

Limestone
292



Fog
289



Deer
286



Wet Sand
287



Cobblestone
302



Cyprus Umber
301



Loam
297



Charcoal
293



Arctic
295

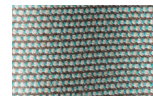

Fjord
248

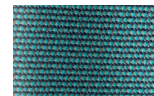

Cerulean
314



Caribbean
298



Atlantic
311

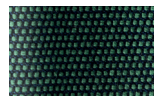

Rainforest
312



Lagoon
249



Cedar
288

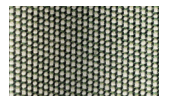

Moss
296

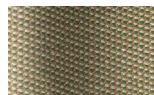

Olive
313

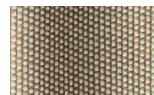

Autumn
315

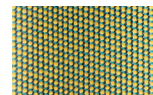

Summer Sky
317



Golden Sand
303



Flamma
304

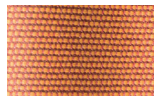

Sunrise
299



Saffron
305



Burnt Sienna
306

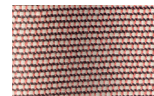

Ash Rose
294

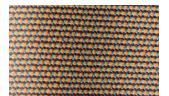

Cooper
316

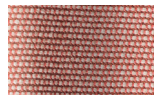

Dusk Pink
307

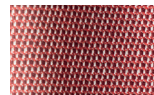

Flamingo
310

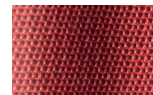

Coral
309

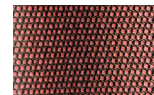

Sandstone
308