

Basics

Duo deckchair arms

by Kettal Studio

**kettal**

# Duo deckchair arms

Designer  
Kettal Studio

Collection  
Triconfort Basics

Reference  
KS8100300

1/3

This design comes from the traditional chairs made of bulrush (Enea) this universal design is very common in different parts of the world: from Mediterranean areas until places in north of Europe.

Throughout the years many updates designs have been made: wood, plastic. Triconfort enea it's an outdoor version made in aluminium with synthetic fibers.

cm/inch

84/33

34/13,3

cm/inch

198 / 77,9

68,5 / 26,9

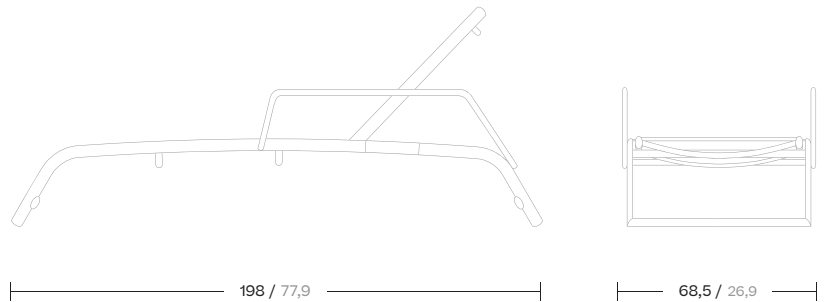

kettal

# Duo deckchair arms

Designer  
Kettal Studio

Collection  
Triconfort Basics

Reference  
KS8100300

2/3

## Materials

Parallel Fabric  
Heavy Load 100.000 Cycles,  
Heavy Load Resistant 1000  
Decitex, Kettalize-It, Resist U.v.  
En-581-4, Easy Clean, Abrasion,  
Resistance 30.000 Cycles,  
Quickdry

Aluminium  
Antioxy, Heavy Load, Resistant  
En-1421, Kettalize-It, Anti-  
Scratch, Easy Clean, Flame  
Retardant M1, Eco Friendly  
Ecoembes Recycling Process

## Maintenance

Clean with mild soap using  
sponge or cloth. Be gentle  
while cleaning, do not scrub  
aggressively the fabric. Once  
cleaned please make sure you  
remove soap excess.  
In case of aggressive stains  
clean with diluted household  
bleach.  
Clean stains promptly. The  
longer it remains, more difficult  
will be to remove.

Once cleaned the fabric steam  
iron the fabric. Just use steam,  
be carefull NOT placing the  
iron directly in the fabric it will  
get damage.

## Frame Colour Options

## Terrain Coatings



Slate Stone  
01C



Mysty Smoke  
02C



Ash  
03C



Bone  
04C



Tuff  
05C

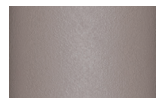

Wet Stone  
06C



Sand Dune  
07C



Dry Clay  
08C



Arabica  
09C



Sepia  
19C



Rose Canyon  
16C



Blossom  
20C



Ruby Dust  
18C



Sunset Glow  
17C



Terrarosa  
15C



Terracota  
14C



Amber  
13C



Ginger Root  
12C



Desert Storm  
11C



African Savannah  
10C



Spring Meadow  
28C

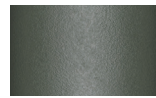

Kombu  
29C



Forest Stream  
27C



Sea Moss  
26C



Glacier Ice  
25C



Polar Sky  
24C



Nightfall  
23C



Indigo  
22C



Wild Lupin  
21C



Galena  
33C

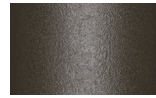

Bronze  
30C



Corten  
31C



Manganese  
32C

# Duo deckchair arms

Designer  
Kettal Studio

Collection  
Triconfort Basics

Reference  
KS8100300

3/3

## Other Characteristics



Stackable 4u.

## Fabric Colour Options

## Parallel Fabrics

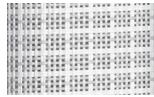

White Anemone  
527

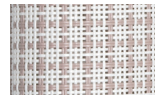

Lace Coral  
528

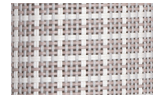

Padina  
564

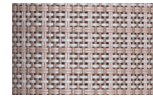

Saline  
571

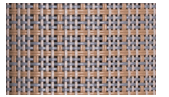

Alaria  
572

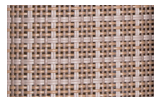

Sponge  
536



Fucus  
537

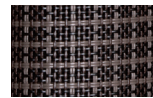

Urchin  
547



Kelp  
556

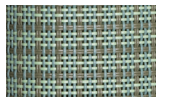

Turtle Grass  
553

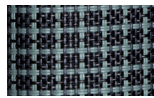

Deep Ocean  
570

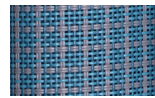

Winter Sea  
569



Xenia  
568



Plumaria  
567

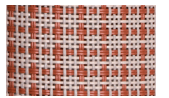

Irish Moss  
559



Coral  
562



Dulse  
565